

Installation Instructions

In wall requirement: Plumber to supply and install a 1/2" BSP male thread in wall.
This set requires a separate wall mixer or wall top assemblies to be paired with it.

1. Install the wall base on to the in-wall thread (use thread tape) with the thread outlet pointing upwards.
2. Install the pillar clip on the wall at a suitable point vertically above the wall base, to hold the main shower riser tube. (the pillar clip needs to be half the length of the main riser tube up or higher, preferably higher is better so not to impede movement of the hand shower slider). You will need to leave half of the C clamp off at this stage which will be added and tightened later once the riser pipe has been installed.
3. Assemble diverter assembly onto short riser with thread tape.
4. Fit the compression nut and olive on to the short riser and insert the short riser into the wall base, tighten the nut firmly with a spanner. *If desired, the short shower riser tubing can be cut to the desired height prior to this step.*
5. Separately fit arch shower arm on the main riser and tighten with thread tape. The slider needs to be added onto the riser at this time if not already on it.
6. Slide the compression nut and olive onto main riser tube and insert the riser into the top of the diverter assembly, tighten the compression nut firmly with a spanner. Add the 2nd half of the pillar clip's C clamp and tighten the clamp screw with a flat-head screwdriver. TAKE CARE – as the riser tube can be easily scratched by pillar clip.
7. Add and tighten the hose and handshower fittings by hand.
8. Attach overhead shower rose with thread tape.

IMPORTANT: Maximum hot water temperature 65°C and 500 kPa Maximum operating pressure at any outlet within a building (Ref AS/NZS 3500)

WARRANTY: The Company accepts responsibility for any fault due to the Company's own workmanship or materials except for subjective variations or random unavoidable blemishes of a minor non-functional nature. This acceptance of responsibility is for 5 years from the date of installation, proof of which may be required.



CB IDEAL TAPWARE PTY LTD

1A DELORAINIE ROAD, EDWARDSTOWN S.A. 5039

PH: (08) 8276 6766 | sales@cbideal.com.au

ABN: 98 156 625035 | ACN: 156 625 035

SA9614 ALCOVE ARCH SHOWER SET WITH HANDSHOWER AND HOSE

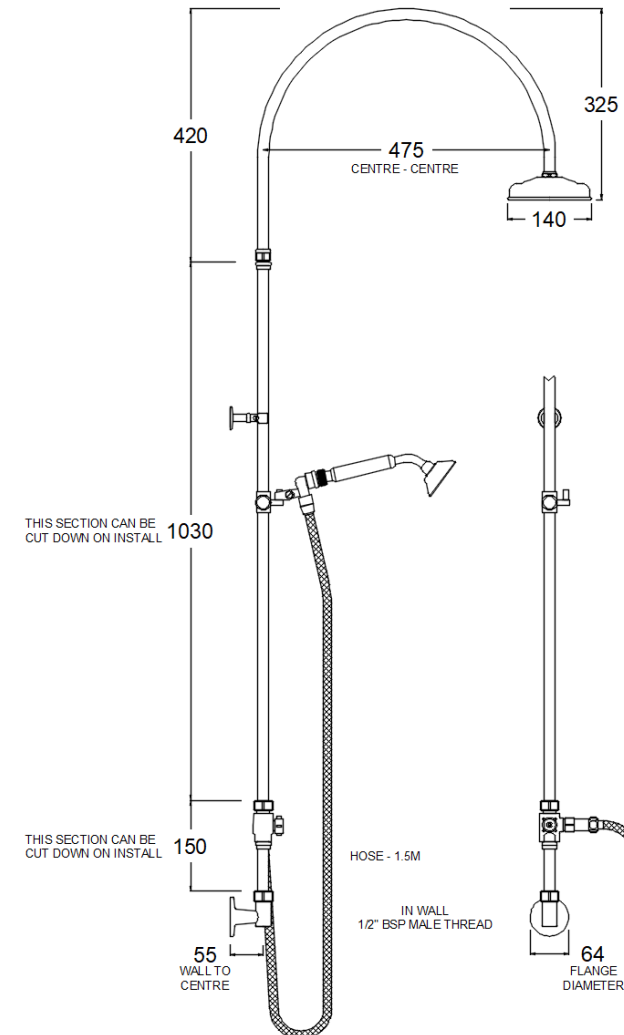

1

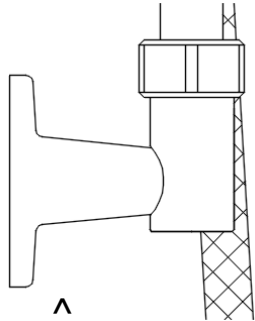

INSTALL WALL BASE WITH THREAD TAPE

2

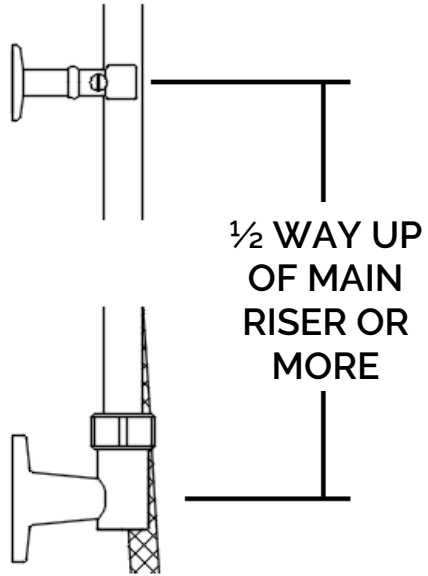

1/2 WAY UP OF MAIN RISER OR MORE

3

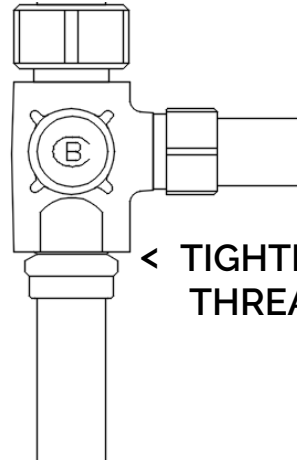

TIGHTEN WITH THREAD TAPE

4

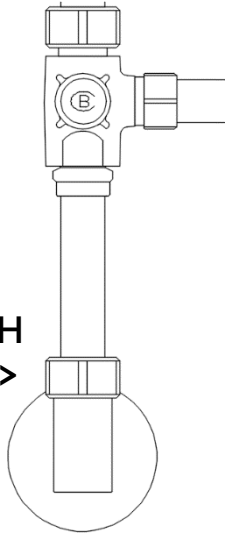

TIGHTEN WITH SPANNER

5

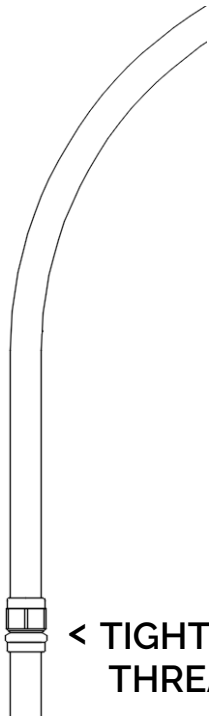

TIGHTEN WITH THREAD TAPE

6

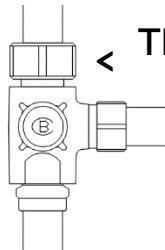

TIGHTEN WITH SPANNER



TIGHTEN WITH SCREWDRIVER

7

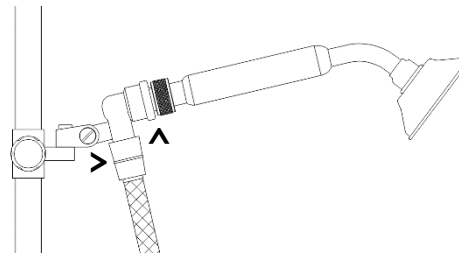

TIGHTEN BY HAND

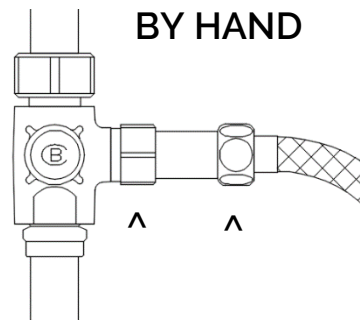

8

TIGHTEN WITH THREAD TAPE

